

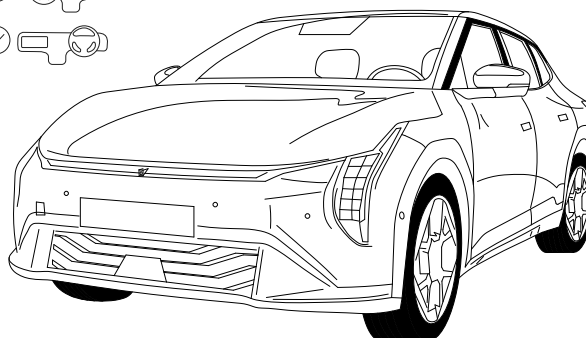

EV4

SZ491ADE00BL/BR



EV4 (CT1, MY 25)
EV4 (SZ1, MY 26)



P 2



P 3 & 8

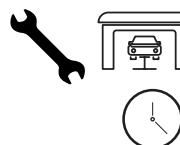

P 4-7

0,3 hours

Genuine Accessories
by MOBIS

 www.mobisparts.eu

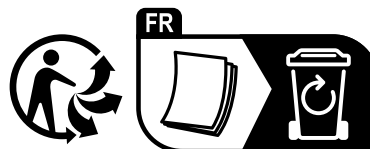

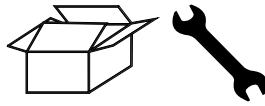

1x



Isopropyl
alcohol

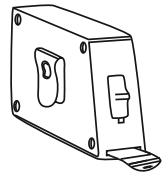
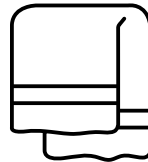
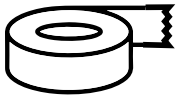



Other languages from
www.mobisparts.eu

(E / PT / I / NL / S / N / DK / FIN / CZ / PL / SK / RO / BG / EST /
HR / HU / LAT / LIT / SER / SVN / UKR / ICE / GR / RUS)

GB

We expressly point out that assembly not carried out properly by a competent installer will result in cancellation of any right to damage compensation, in particular those arising by virtue of the product liability act.

Contents of these kits and their fitting manuals are subject to alteration without notice, please ensure that these instructions are read and fully understood before commencing installation.

F

Nous tenons à insister tout particulièrement sur le fait que si ce produit n'est pas correctement assemblé par un technicien compétent, aucun droit de compensation ne sera recevable en cas de dommages, notamment les droits en vertu de la loi concernant la responsabilité à l'égard des produits.

Le contenu de ce produit, ainsi que des guides de montage qui les accompagnent est sujet à modifications sans préavis; lisez attentivement ces instructions avant de procéder à l'installation.

D

Wir weisen ausdrücklich darauf hin, dass eine nicht fachgerecht durchgeführte Montage zum Erlöschen jeglicher Schadensersatzansprüche, insbesondere nach dem Produkthaftungsgesetz, führt.

Änderungen des Inhalts dieser Montagesätze und der dazugehörigen Einbauanleitungen bleiben vorbehalten. Bitte stellen Sie sicher, dass Sie diese Anleitungen vor Beginn der Montage gelesen und vollständig verstanden haben.



**BBD/best before date
EXP/expiration date
Use by**



**18° - 40°C
65° - 104°F**



This product contains fixation material with an expiration date. Do not install this product if one or more expiration dates have been passed.

Both the vehicle and the workshop are required to have a temperature between 65° and 104°F.

Attention: The workshop is to be dry, well ventilated and drained.

Ce produit contient du matériel de fixation avec une date d'expiration. Ne pas installer ce produit si une ou plusieurs dates d'expiration sont périmés.

Le véhicule et l'atelier doivent avoir une température comprise entre 18° et 40°C.

Attention: L'atelier doit être sec, bien ventilé et drainé.

Dieses Produkt beinhaltet Befestigungsmaterialien mit einem Verfallsdatum. Dieses Produkt nicht installieren wenn eines oder mehrere Verfallsdaten überschritten sind.

Die Temperatur von Fahrzeug und Werkstatt soll zwischen 18° and 40°C liegen.

Achtung: Die Werkstatt soll sich in einem trockenen und gut belüfteten Zustand befinden.

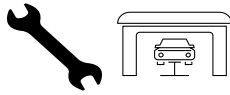

GB

@ Fig. 1

Clean the indicated area with car shampoo.

Clean the indicated area with isopropyl alcohol to remove any wax or oily remains from the paint. Do not use any solution or detergent that will leave an oily film on the paint.

F

@ Fig. 1

Nettoyez la zone indiquée avec un shampoing de voiture.

Nettoyez la zone indiquée avec de l'alcool isopropylique pour enlever toute cire ou de corps gras de la peinture. Ne pas utiliser de solution ou de détergent qui va laisser de film gras sur la peinture.

D

@ Fig. 1

Den angegebenen Bereich mit Autoshampono reinigen.

Den angegebenen Bereich mit Isopropyl-Alkohol reinigen um Wachs oder Ölrückstände vom Lack zu entfernen. Bitte benutzen Sie keine Lösung die einen Ölfilm auf dem Lack hinterlässt.

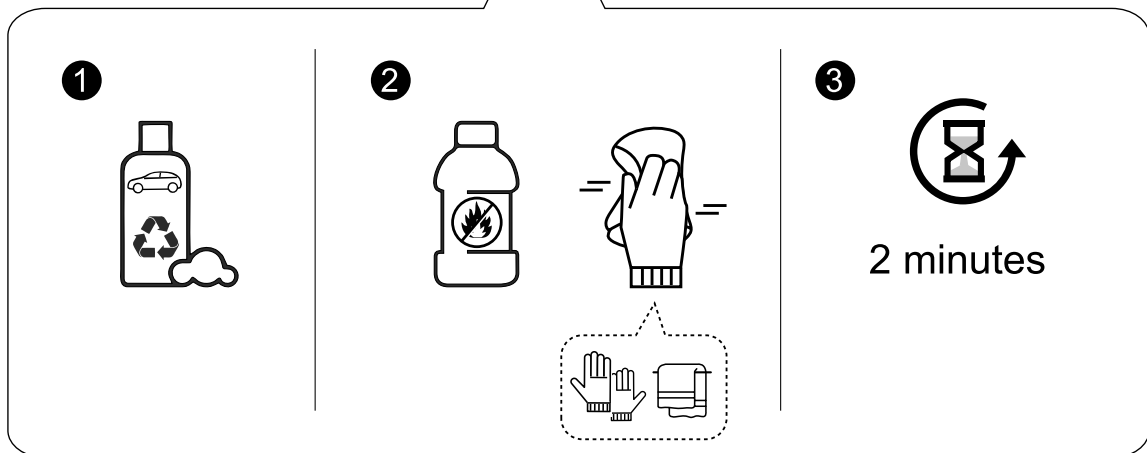
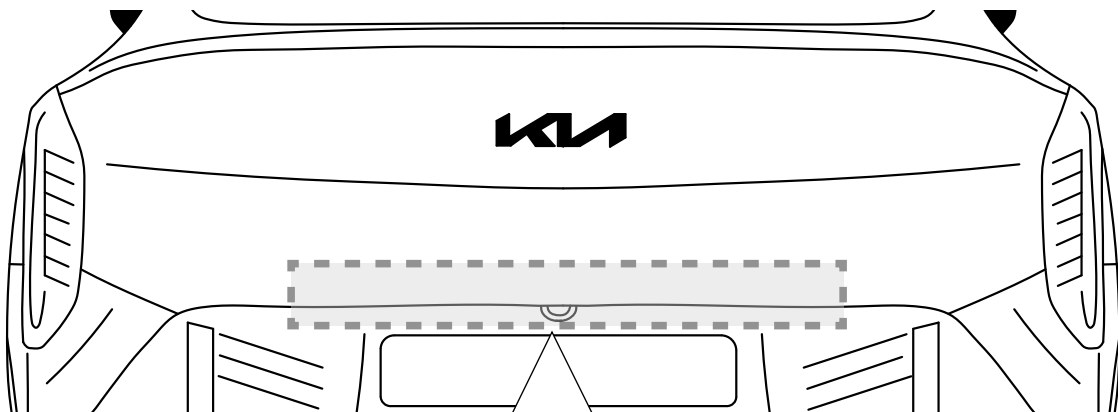

Fig. 1

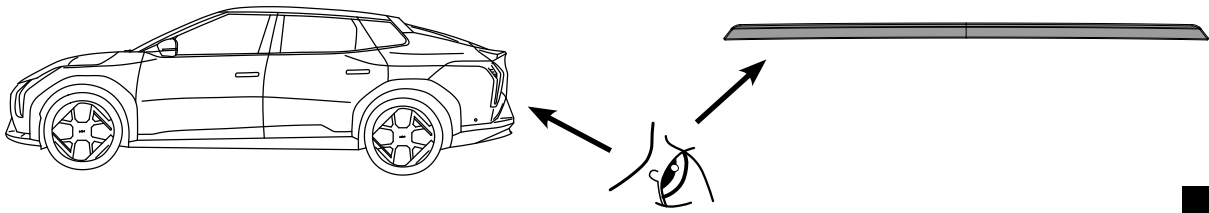
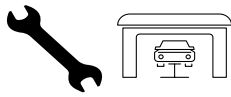

Fig. 2

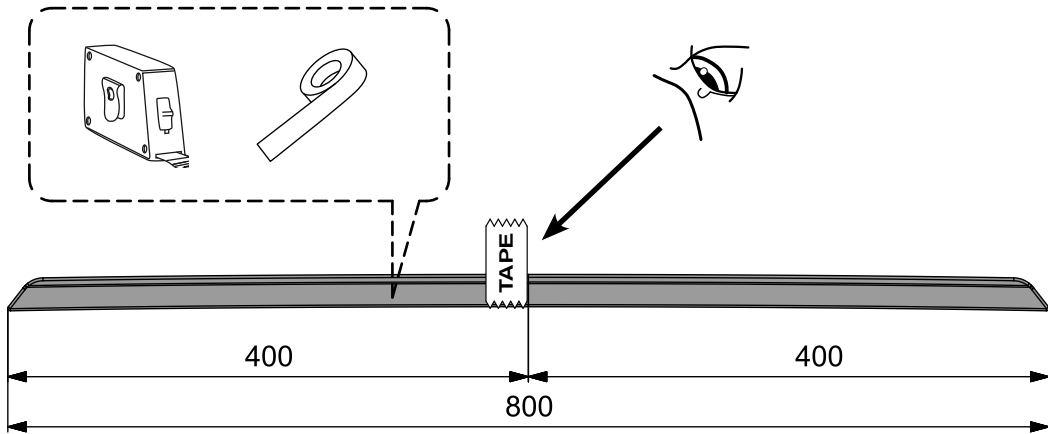
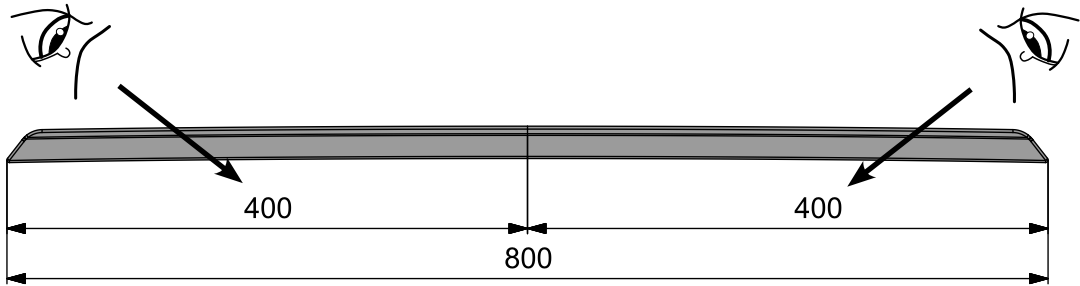

Fig. 3

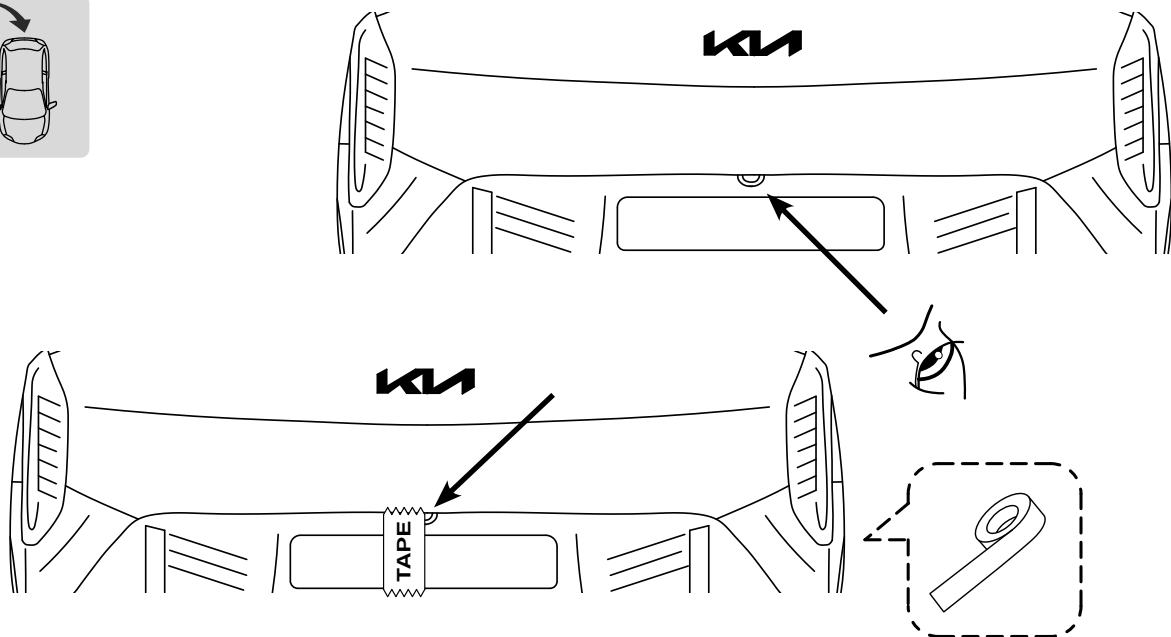
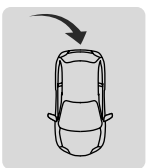

Fig. 4

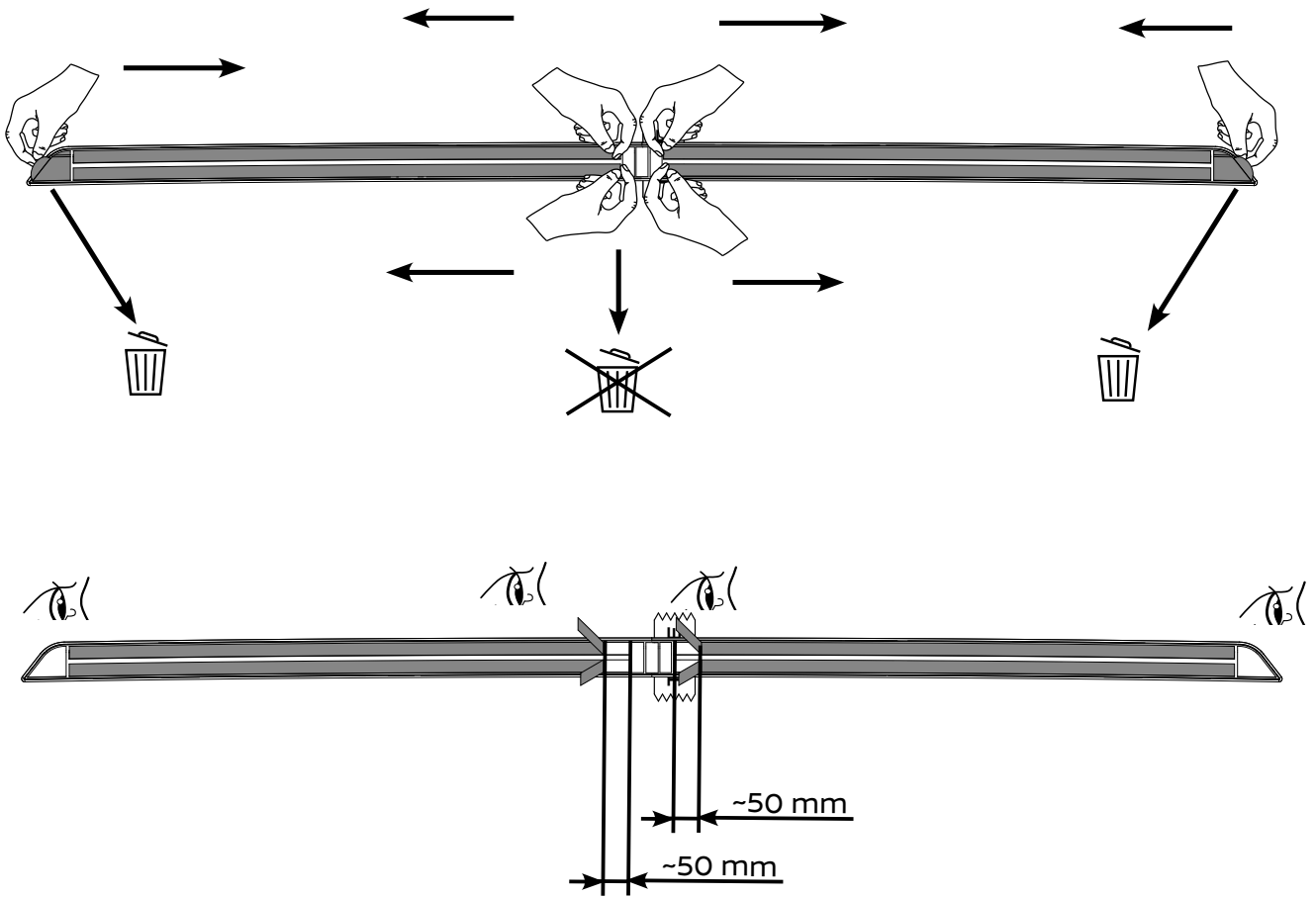
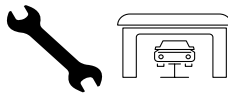

Fig. 5

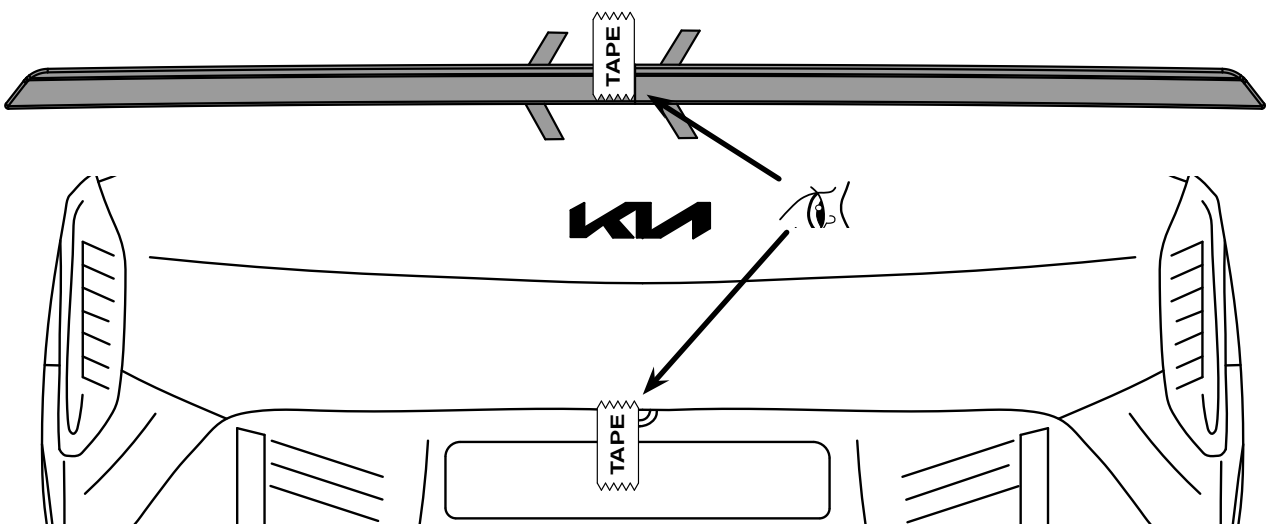
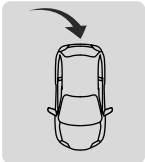

Fig. 6

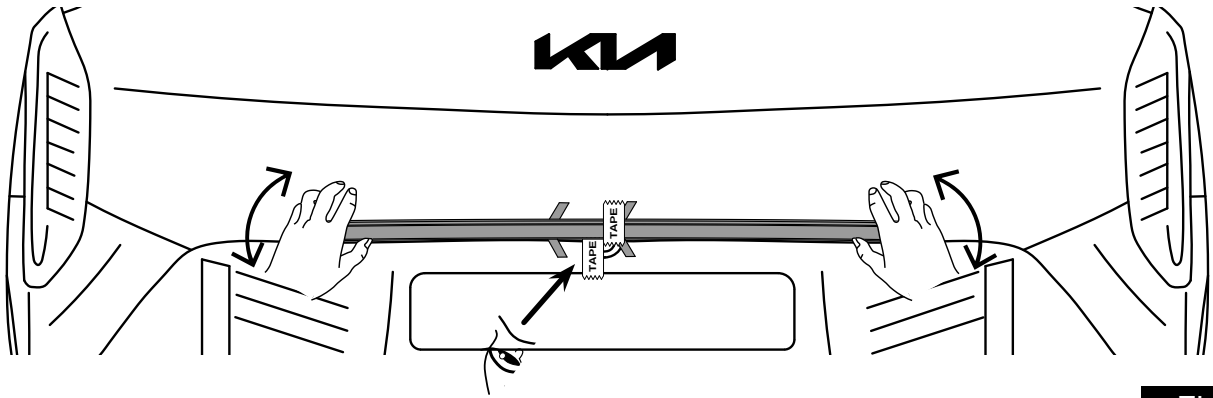
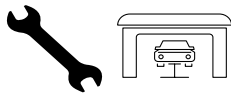

Fig. 7

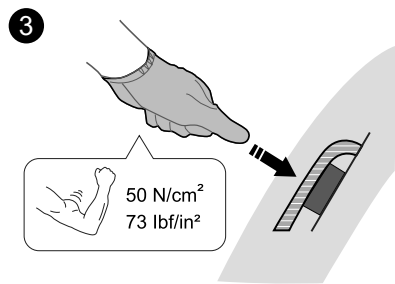
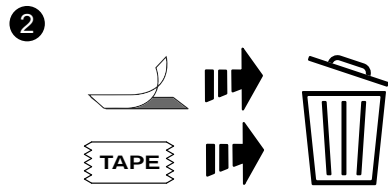
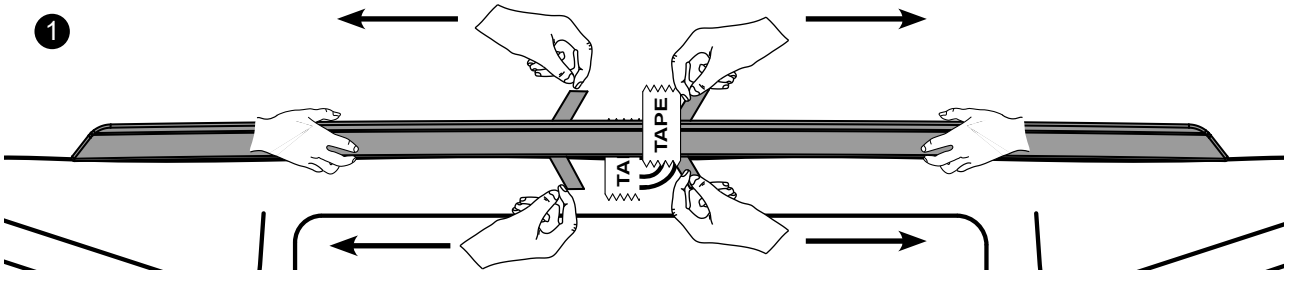

Fig. 8

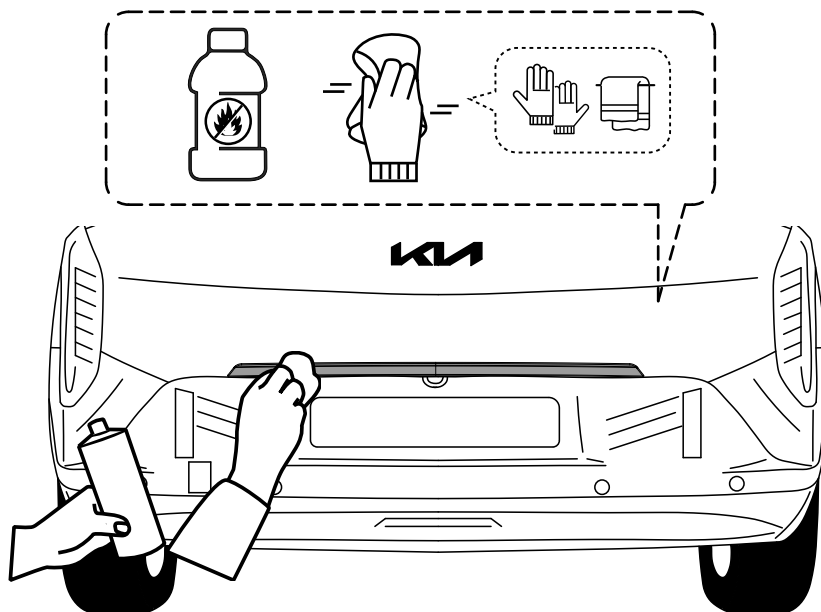
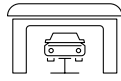

Fig. 9



GB

Maximum speed of 62mph the first 24 hours after installation.

No car wash within the first 48 hours after installation, neither by machine, nor by hand.

F

Vitesse maximale de 100km/h pendant 24 heures après l'installation.

Pas de lavage de voiture dans les premières 48 heures après l'installation, pas à la machine ou à la main.

D

Die maximale Geschwindigkeit beträgt 100km/h innerhalb der ersten 24 Stunden.

Keine Fahrzeugwäsche bis zu 48 Stunden nach dem Einbau (Waschanlage oder Handwäsche).

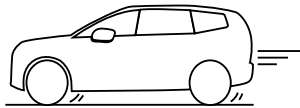

24 hr

max. 100km/h
max. 62mph

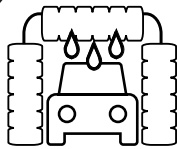

48 hr



Dealer installation



Information & warnings for dealer